

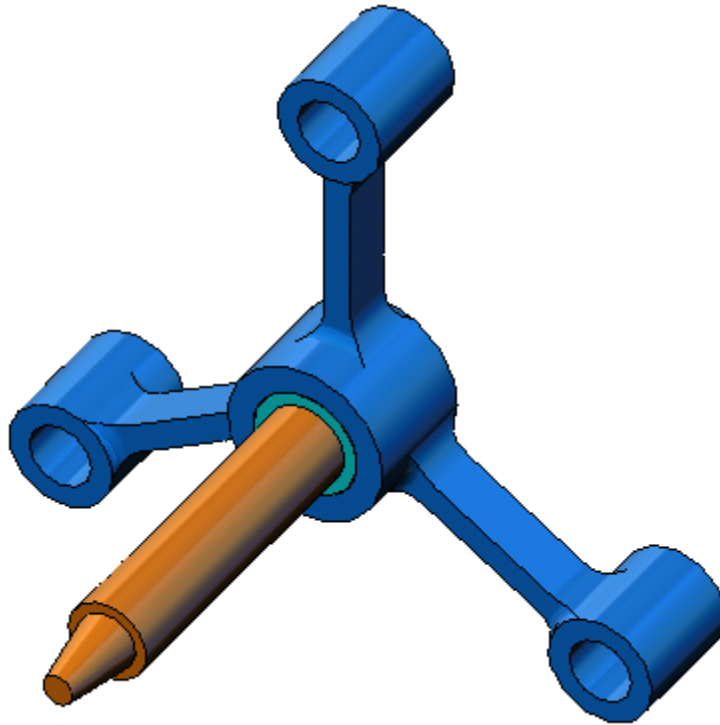

An Introduction to Stress Analysis Applications with SolidWorks Simulation, Instructor Guide



© 1995-2010, Dassault Systèmes SolidWorks Corporation, a Dassault Systèmes S.A. company, 300 Baker Avenue, Concord, Mass. 01742 USA. All Rights Reserved.

The information and the software discussed in this document are subject to change without notice and are not commitments by Dassault Systèmes SolidWorks Corporation (DS SolidWorks).

No material may be reproduced or transmitted in any form or by any means, electronically or manually, for any purpose without the express written permission of DS SolidWorks.

The software discussed in this document is furnished under a license and may be used or copied only in accordance with the terms of the license. All warranties given by DS SolidWorks as to the software and documentation are set forth in the license agreement, and nothing stated in, or implied by, this document or its contents shall be considered or deemed a modification or amendment of any terms, including warranties, in the license agreement.

Patent Notices

SolidWorks® 3D mechanical CAD software is protected by U.S. Patents 5,815,154; 6,219,049; 6,219,055; 6,611,725; 6,844,877; 6,898,560; 6,906,712; 7,079,990; 7,477,262; 7,558,705; 7,571,079; 7,590,497; 7,643,027; 7,672,822; 7,688,318; 7,694,238; 7,853,940; and foreign patents, (e.g., EP 1,116,190 and JP 3,517,643).

eDrawings® software is protected by U.S. Patent 7,184,044; U.S. Patent 7,502,027; and Canadian Patent 2,318,706.

U.S. and foreign patents pending.

Trademarks and Product Names for SolidWorks Products and Services

SolidWorks, 3D PartStream.NET, 3D ContentCentral, eDrawings, and the eDrawings logo are registered trademarks and FeatureManager is a jointly owned registered trademark of DS SolidWorks.

CircuitWorks, Feature Palette, FloXpress, PhotoWorks, TolAnalyst, and XchangeWorks are trademarks of DS SolidWorks.

FeatureWorks is a registered trademark of Geometric Software Solutions Ltd.

SolidWorks 2011, SolidWorks Enterprise PDM, SolidWorks Simulation, SolidWorks Flow Simulation, and eDrawings Professional are product names of DS SolidWorks.

Other brand or product names are trademarks or registered trademarks of their respective holders.

COMMERCIAL COMPUTER SOFTWARE - PROPRIETARY

U.S. Government Restricted Rights. Use, duplication, or disclosure by the government is subject to restrictions as set forth in FAR 52.227-19 (Commercial Computer Software - Restricted Rights), DFARS 227.7202 (Commercial Computer Software and Commercial Computer Software Documentation), and in the license agreement, as applicable.

Contractor/Manufacturer:

Dassault Systèmes SolidWorks Corporation, 300 Baker Avenue, Concord, Massachusetts 01742 USA

Copyright Notices for SolidWorks Standard, Premium, Professional, and Education Products

Portions of this software © 1986-2010 Siemens Product Lifecycle Management Software Inc. All rights reserved.

Portions of this software © 1986-2010 Siemens Industry Software Limited. All rights reserved.

Portions of this software © 1998-2010 Geometric Ltd.

Portions of this software © 1996-2010 Microsoft Corporation. All rights reserved.

Portions of this software incorporate PhysX™ by NVIDIA 2006-2010.

Portions of this software © 2001 - 2010 Luxology, Inc. All rights reserved, Patents Pending.

Portions of this software © 2007 - 2010 DriveWorks Ltd.

Copyright 1984-2010 Adobe Systems Inc. and its licensors. All rights reserved. Protected by U.S. Patents 5,929,866; 5,943,063; 6,289,364; 6,563,502; 6,639,593; 6,754,382; Patents Pending.

Adobe, the Adobe logo, Acrobat, the Adobe PDF logo, Distiller and Reader are registered trademarks or trademarks of Adobe Systems Inc. in the U.S. and other countries.

For more copyright information, in SolidWorks see Help > About SolidWorks.

Copyright Notices for SolidWorks Simulation Products

Portions of this software © 2008 Solversoft Corporation.

PCGLSS © 1992-2007 Computational Applications and System Integration, Inc. All rights reserved.

Copyright Notices for Enterprise PDM Product

Outside In® Viewer Technology, © Copyright 1992-2010, Oracle

© Copyright 1995-2010, Oracle. All rights reserved.

Portions of this software © 1996-2010 Microsoft Corporation. All rights reserved.

Copyright Notices for eDrawings Products

Portions of this software © 2000-2010 Tech Soft 3D.

Portions of this software © 1995-1998 Jean-Loup Gailly and Mark Adler.

Portions of this software © 1998-2001 3Dconnexion.

Portions of this software © 1998-2010 Open Design Alliance. All rights reserved.

Portions of this software © 1995-2009 Spatial Corporation.

This software is based in part on the work of the Independent JPEG Group.

Lesson 2: Adaptive Methods in SolidWorks Simulation

Goals of This Lesson

- ❑ Introduce the concept of adaptive methods for static studies. Upon successful completion of this lesson, the students should be able to understand the basic concepts behind adaptive methods, and how SolidWorks Simulation implements them.
- ❑ Analyze a portion of the model instead of the whole model. In the second part of this lesson, the students will analyze a quarter of the original model using symmetry fixtures. They should be able to recognize under which conditions they can apply symmetry fixtures without jeopardizing the accuracy of the results.
- ❑ Introduce the concept of shell meshing. The differences between a shell and solid mesh are highlighted in the project discussion. The students should be able to recognize which models are better suited for shell meshing.
- ❑ Compare SolidWorks Simulation results with known theoretical solutions. A theoretical solution exists for the problem described in this lesson. For the class of problems that have analytical solutions, the students should be able to derive the error percentages and decide if the results are acceptable or not.

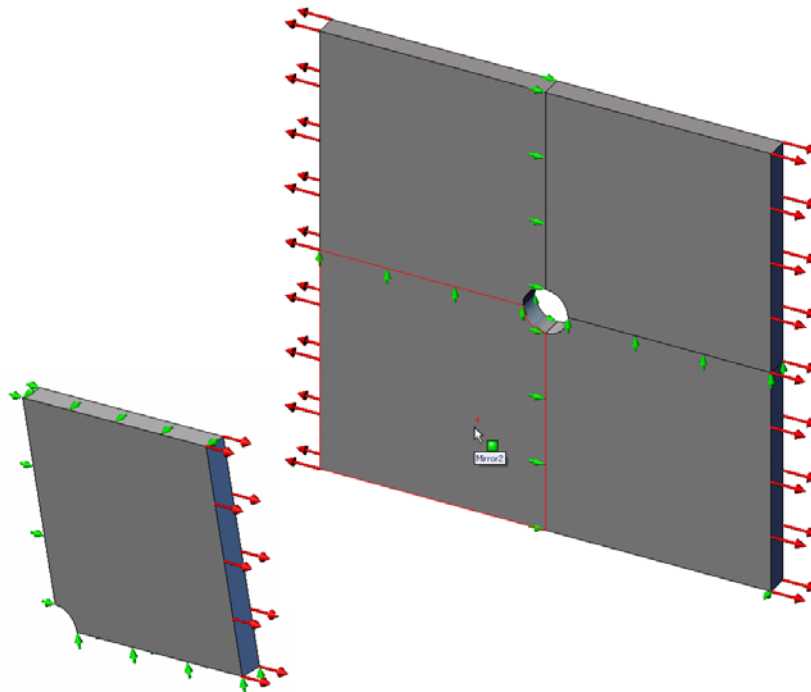

Outline

- Active Learning Exercise — Adaptive Methods in SolidWorks Simulation
 - **Part 1**
 - Opening the Plate-with-hole.SLDPRT Document
 - Checking the SolidWorks Simulation Menu
 - Saving the Model to a Temporary Directory
 - Setting the Analysis Units
 - Step 1: Creating a Static Study
 - Step 2: Assigning Materials
 - Step 3: Applying Fixtures
 - Step 4: Applying Pressure
 - Step 5: Meshing the Model and Running the Analysis
 - Step 6: Visualizing the Results
 - Step 7: Verifying the Results
 - **Part 2**
 - Modeling a Quarter of the Plate Applying Symmetry Fixtures
 - **Part 3**
 - Applying the h-adaptive Method
- 5 Minute Assessment
- In Class Discussion-Creating a Frequency Study
- Exercises and Projects-Modeling the Quarter Plate with a Shell Mesh
- Lesson Summary

Active Learning Exercise — Part 1

Use SolidWorks Simulation to perform static analysis on the `Plate-with-hole.SLDPRT` part shown to the right.

You will calculate the stresses of a 500mm x 500mm x 25mm (19.68in x 19.68in x 0.98in) square plate with a 25mm (0.98in) radius hole at its center. The plate is subjected to a 1 MPa (145.04 psi) tensile pressure.

You will compare the stress concentration at the hole with known theoretical results.

The step-by-step instructions are given below.

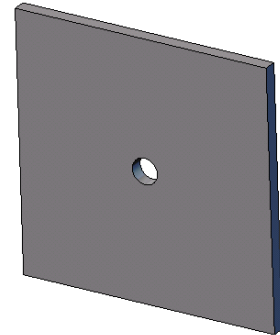

Creating `Simulationtemp` directory

We recommend that you save the `SolidWorks Simulation Education Examples` to a temporary directory to save the original copy for repeated use.

- 1 Create a temporary directory named `Simulationtemp` in the `Examples` folder of the `SolidWorks Simulation` installation directory.
- 2 Copy the `SolidWorks Simulation Education Examples` directory into the `Simulationtemp` directory.

Opening the `Plate-with-hole.SLDPRT` Document

- 1 Click **Open**  on the Standard toolbar. The **Open** dialog box appears.
- 2 Navigate to the `Simulationtemp` folder in the `SolidWorks Simulation` installation directory.
- 3 Select `Plate-with-hole.SLDPRT`.
- 4 Click **Open**.

The `Plate-with-hole.SLDPRT` part opens.

Notice that the part has two configurations: (a) `Quarter plate`, and (b) `Whole plate`. Make sure that `Whole plate` configuration is active.

Note: The configurations of the document are listed under the `ConfigurationManager` tab  at the top of the left pane.

Checking the SolidWorks Simulation Menu

If SolidWorks Simulation is added-in, the SolidWorks Simulation menu appears on the SolidWorks menu bar.



SolidWorks Simulation menu

If not:

- 1 Click **Tools, Add-Ins**.

The **Add-Ins** dialog box appears.

- 2 Check the checkboxes next to SolidWorks Simulation.

If SolidWorks Simulation is not in the list, you need to install SolidWorks Simulation.

- 3 Click **OK**.

The SolidWorks Simulation menu appears on the SolidWorks menu bar.

Setting the Analysis Units

Before we start this lesson, we will set the analysis units.

- 1 Click **Simulation, Options**.

- 2 Click the **Default Options** tab.

- 3 Select **SI (MKS)** in **Unit system** and **mm** and **N/mm²(MPa)** as the units for the length and stress, respectively.

- 4 Click .

Step 1: Creating a Study

The first step in performing analysis is to create a study.

- 1 Click **Simulation, Study** in the main SolidWorks menu on the top of the screen.

The **Study** PropertyManager appears.

- 2 Under **Name**, type `Whole plate`.

- 3 Under **Type**, select **Static**.

- 4 Click .

SolidWorks Simulation creates a Simulation study tree located beneath the FeatureManager design tree.

Step 2: Assigning Material

Assign Alloy Steel

- 1 In the SolidWorks Simulation Manager tree, right-click the Plate-with-hole folder and click **Apply Material to All Bodies**.

The **Material** dialog box appears.

- 2 Do the following:
 - a) Expand the SolidWorks Materials library
 - b) Expand the Steel category.
 - c) Select **Alloy Steel**.

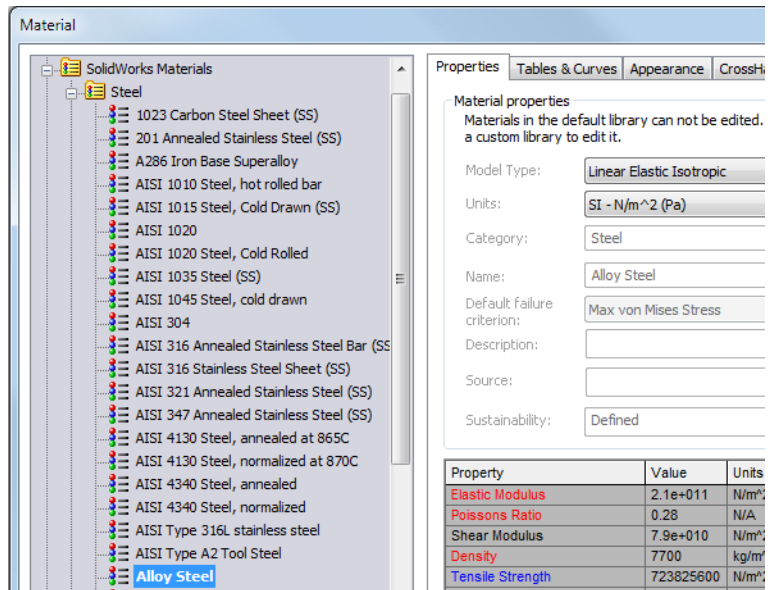

Note: The mechanical and physical properties of Alloy Steel appear in the table to the right.

- 3 Click **OK**.

Step 3: Applying Fixtures

You apply fixtures to prevent the out of plane rotations and free body motions.

- 1 Press spacebar and select ***Trimetric** in the **Orientation** menu.
The model orientation is as shown in the figure.
- 2 In the Simulation study tree, right-click the **Fixtures** folder and click **Advanced Fixtures**.
The **Fixture** PropertyManager appears.
- 3 Make sure that **Type** is set to **Use Reference Geometry**.
- 4 In the graphics area, select the 8 edges shown in the figure.

Edge<1> through Edge<8> appear in the **Faces, Edges, Vertices for Fixture** box.

- 5 Click in the **Face, Edge, Plane, Axis for Direction** box and select **Plane1** from the flyout FeatureManager tree.
- 6 Under **Translations**, select **Along plane Dir 2**.

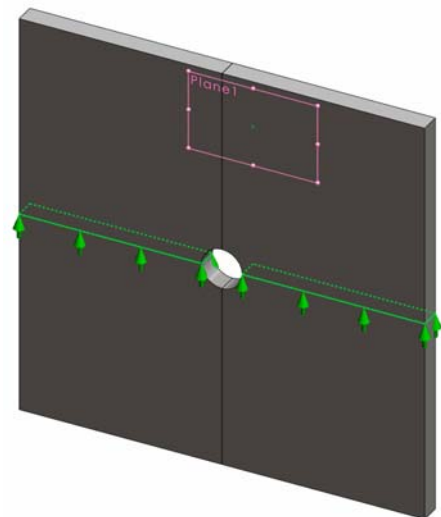

- 7 Click .

The fixtures are applied and their symbols appear on the selected edges.

Also, a fixture icon  (Reference Geometry-1) appears in the Fixtures folder.

Similarly, you follow steps 2 to 7 to apply fixtures to the vertical set of edges as shown in the figure to restrain the 8 edges **Along plane Dir 1**  of Plane1.

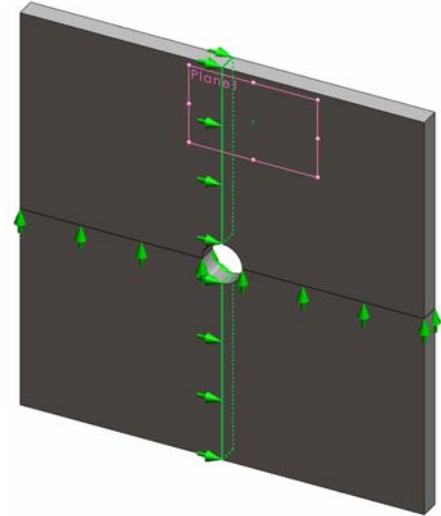

To prevent displacement of the model in the global Z-direction, a fixture on the vertex shown in the figure below must be defined.

- 1 In the SolidWorks Simulation Manager tree, right-click the Fixtures folder and click **Advanced Fixtures**.

The **Fixture** PropertyManager appears.

- 2 Make sure that **Type** is set to **Use reference geometry**.

- 3 In the graphics area, click the vertex shown in the figure.

Vertex<1> appears in the **Faces, Edges, Vertices for Fixture** box.

- 4 Click in the **Face, Edge, Plane, Axis for Direction** box and select Plane1 from the flyout FeatureManager tree.

- 5 Under **Translations**, select **Normal to Plane** .

- 6 Click .

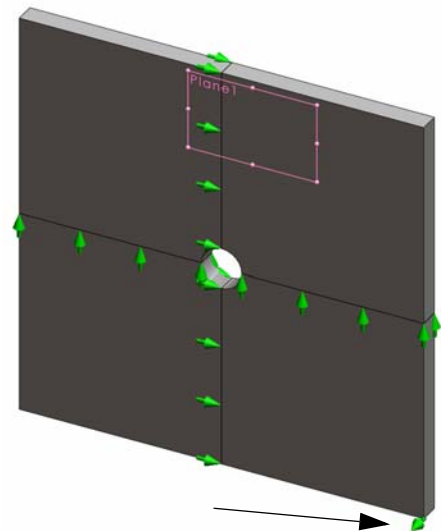

Step 4: Applying Pressure



You apply a 1 MPa (145.04 psi) pressure normal to the faces as shown in the figure.

- 1 In the SolidWorks Simulation Manager tree, right-click the External Loads folder and click **Pressure**.

The **Pressure** PropertyManager appears.

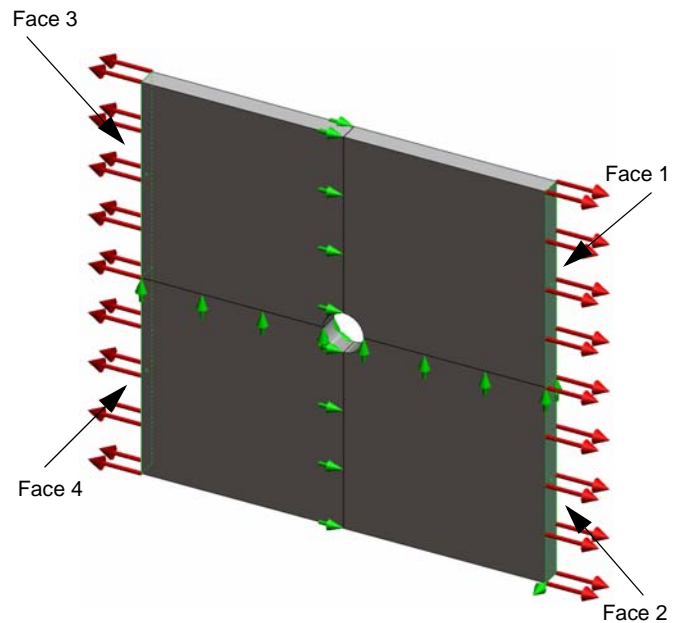
- 2 Under **Type**, select **Normal to selected face**.
- 3 In the graphics area, select the four faces as shown in the figure.
Face<1> through Face<4> appear in the **Faces for Pressure** list box.



- 4 Make sure that **Units** is set to **N/mm² (MPa)**.
- 5 In the **Pressure value** box , type 1.
- 6 Check the **Reverse direction** box.
- 7 Click .





SolidWorks Simulation applies the normal pressure to the selected faces and Pressure-1 icon  appears in the External Loads folder.

To Hide Fixtures and Loads Symbols

In the SolidWorks Simulation Manager tree, right-click the Fixtures or External Loads folder and click **Hide All**.

Step 5: Meshing the Model and Running the Study

Meshing divides your model into smaller pieces called elements. Based on the geometrical dimensions of the model SolidWorks Simulation suggests a default element size which can be changed as needed.

- 1 In the SolidWorks Simulation Manager tree, right-click the Mesh icon and select **Create Mesh**.
The **Mesh** PropertyManager appears.
- 2 Expand **Mesh Parameters** by selecting the check box.
Make sure that **Curvature based mesh** is selected.
- 3 Type **50mm** for **Maximum element size** , and accept the default values for the rest of the parameters (**Minimum element size** , **Min number of elements in a circle**  and **Element size growth ratio** ).

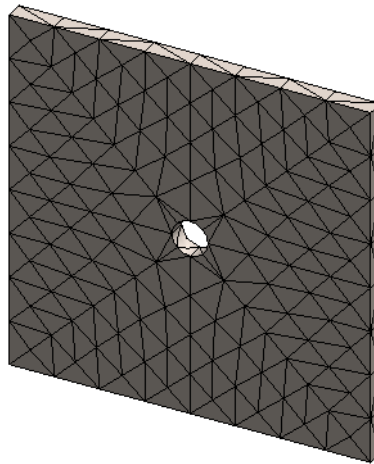

- 4 Check **Run (solve) the analysis** under **Options** and click .

Note: To see the mesh plot, right-click Mesh folder and select **Show Mesh**



Step 6: Visualizing the Results

Normal Stress in the global X-direction.

- 1 Right-click the **Results** folder  and select **Define Stress Plot**.
The **Stress Plot** PropertyManager appears.
- 2 Under **Display**
 - a) Select **SX: X Normal stress** in the **Component** field.
 - b) Select **N/mm² (MPa)** in **Units**.
- 3 Click .

The normal stress in the X-direction plot is displayed.

Notice the concentration of stresses in the area around the hole.

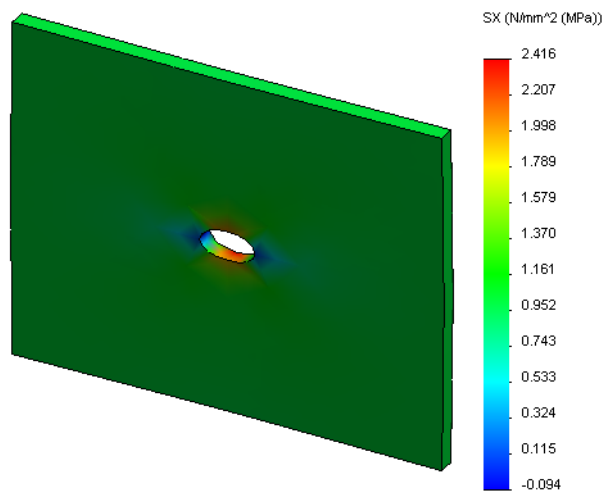

Step 7: Verifying the Results

The maximum normal stress σ_{\max} for a plate with a rectangular cross section and a central circular hole is given by:

$$\sigma_{max} = k \cdot \left(\frac{P}{t(D-2r)} \right) \qquad k = 3.0 - 3.13 \left(\frac{2r}{D} \right) + 3.66 \left(\frac{2r}{D} \right)^2 - 1.53 \left(\frac{2r}{D} \right)^3$$

where:

D = plate width = 500mm (19.69in)

r = hole radius = 25mm (0.98in)

t = plate thickness = 25mm (0.98in)

P = Tensile axial force = Pressure * (D * t)

The analytical value for the maximum normal stress is $\sigma_{\max} = 3.0245$ MPa (438.67 psi).

The SolidWorks Simulation result, without using any adaptive methods, is SX = 2.416 MPa (350.41 psi).

This result deviates from the theoretical solution by approximately 20.1%. You will soon see that this significant deviation can be attributed to the coarseness of the mesh.

Active Learning Exercise — Part 2

In the second part of the exercise you will model a quarter of the plate with help of the symmetry fixtures.

Note: The symmetry fixtures can be used to analyze a portion of the model only. This approach can considerably save the analysis time, particularly if you are dealing with large models.

Symmetry conditions require that geometry, loads, material properties and fixtures are equal across the plane of symmetry.

Step 1: Activate New Configuration

1 Click the ConfigurationManager tab .

2 In the **Configuration Manager** tree double-click the Quarter plate icon.

The Quarter plate configuration will be activated.

The model of the quarter plate appears in the graphics area.



Note: To access a study associated with an inactive configuration right-click its icon and select **Activate SW configuration**.



Step 2: Creating a Study

The new study that you create is based on the active Quarter plate configuration.

1 Click **Simulation, Study** in the main SolidWorks menu on the top of the screen.

The **Study PropertyManager** appears.

2 Under **Name**, type Quarter plate.

3 Under **Type**, select **Static**.

4 Click .

SolidWorks Simulation creates a representative tree for the study located in a tab at the bottom of the screen.

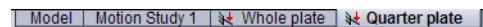

Step 3: Assigning Material

Follow the procedure described in Step 2 of Part 1 to assign **Alloy Steel** material.

Step 4: Applying Fixtures

You apply fixtures on the faces of symmetry.

- 1 Use the **Arrow** keys to rotate the model as shown in the figure.
- 2 In the Simulation study tree, right-click the **Fixtures** folder and select **Advanced Fixtures**.

The **Fixtures** PropertyManager appears.

- 3 Set **Type** to **Symmetry**.
- 4 In the graphics area, click the **Face 1** and **Face 2** shown in the figure.

Face<1> and Face<2> appear in the **Planar Faces for Fixture** box.

- 5 Click .

Next you restrain the upper edge of the plate to prevent the displacement in the global Z-direction.

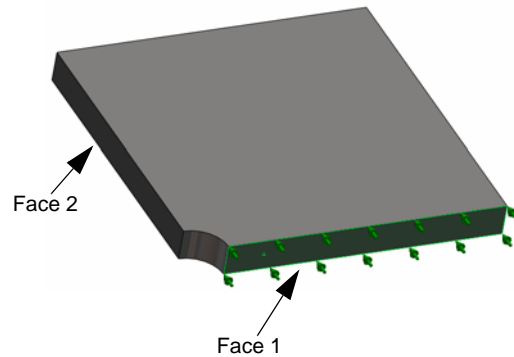

To restrain the upper edge:

- 1 In the SolidWorks Simulation Manager tree, right-click the **Fixtures** folder and select **Advanced Fixtures**.

Set **Type** to **Use reference geometry**.

- 2 In the graphics area, click the upper edge of the plate shown in the figure.
Edge<1> appears in the **Faces, Edges, Vertices for Fixture** box.

- 3 Click in the **Face, Edge, Plane, Axis for Direction** box and select **Plane1** from the flyout FeatureManager tree.

- 4 Under **Translations**, select **Normal to plane** . Make sure the other two components are deactivated.

- 5 Click .

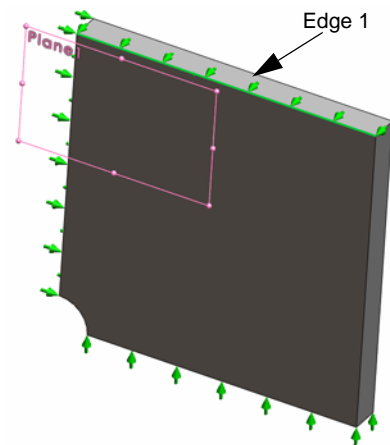

After applying all fixtures, two items: (Symmetry-1) and (Reference Geometry-1) appear in the **Fixtures** folder.



Step 5 Applying Pressure

You apply a 1 MPa (145.04 psi) pressure as shown in the figure below:

- 1 In the SolidWorks Simulation Manager tree, right-click **External Loads** and select **Pressure**.

The **Pressure** PropertyManager appears.

- 2 Under **Type**, select **Normal to selected face**.
- 3 In the graphics area, select the face shown in the figure.

- 1 Face<1> appears in the **Faces for Pressure** list box.
- 2 Set **Units**  to **N/mm² (MPa)**.
- 3 In the **Pressure value** box , type **1**.
- 4 Check the **Reverse direction** box.
- 5 Click .

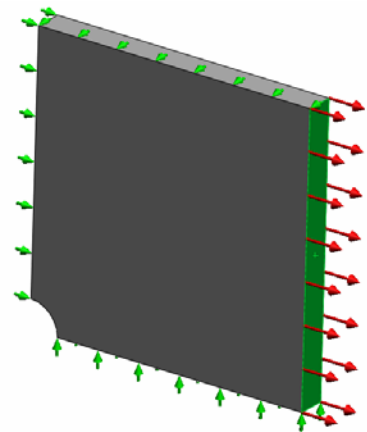

SolidWorks Simulation applies the normal pressure to the selected face and **Pressure-1** icon  appears in the **External Loads** folder.

Step 6 Meshing the Model and Running the Analysis

Apply the same mesh settings following the procedure described in Step 5 of Part 1, Meshing the Model and Running the Study on page 2-7. Then **Run** the analysis.

The mesh plot is as shown in the figure.

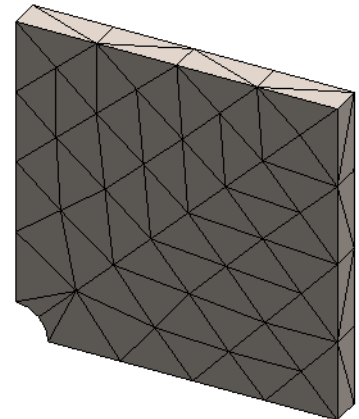

Step 7 Viewing Normal Stresses in the Global X- Direction

- 1 In the Simulation study tree, right-click the **Results** folder  and select **Define Stress Plot**.
- 2 In the **Stress Plot** PropertyManager, under **Display**:
 - a) Select **SX:X Normal stress**.
 - b) Select **N/mm² (MPa)** in **Units**.
- 3 Under **Deformed Shape** select **True Scale**.
- 4 Under **Property**:
 - a) Select **Associate plot with name view orientation**.
 - b) Select ***Front** from the menu.

5 Click .

The normal stress in the X-direction is displayed on the real deformed shape of the plate.

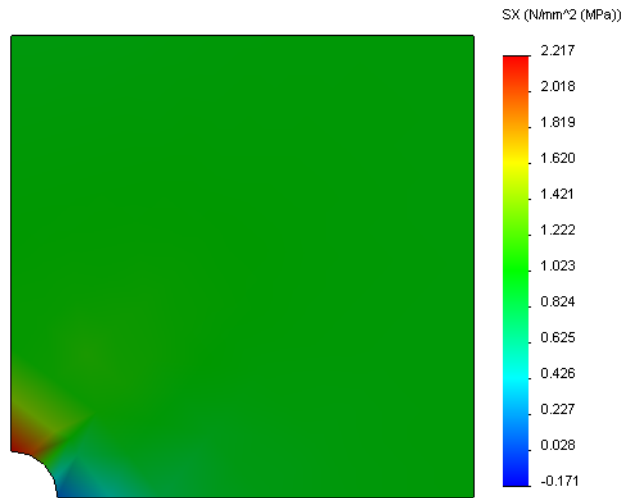

Step 8 Verifying the Results

For the quarter model, the maximum normal SX stress is 2.217 MPa (321.55 psi). This result is comparable to the results for the whole plate.

This result deviates from the theoretical solution by approximately 36%. As was mentioned in the conclusion of Part 1 of this lesson, you will see that this deviation can be attributed to the coarseness of the computational mesh. You can improve the accuracy by using a smaller element size manually or by using automatic adaptive methods.

In Part 3 you will use the h-adaptive method to improve the accuracy.

Active Learning Exercise — Part 3

In the third part of the exercise you will apply the h-adaptive method to solve the same problem for the `Quarter plate` configuration.

To demonstrate the power of the h-adaptive method, first, you will mesh the model with a large element size, and then you will observe how the h-method changes the mesh size to improve the accuracy of the results.

Step 1 Defining a New Study

You will create a new study by duplicating the previous study.

- 1 Right-click the `Quarter plate` study at the bottom of the screen and select **Duplicate**.

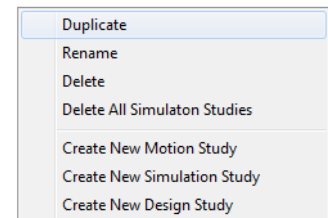

The **Define Study Name** dialog box appears.

- 2 In the **Study Name** box, type `H-adaptive`.
- 3 Under **Configuration to use**: select **Quarter plate**.
- 4 Click **OK**.

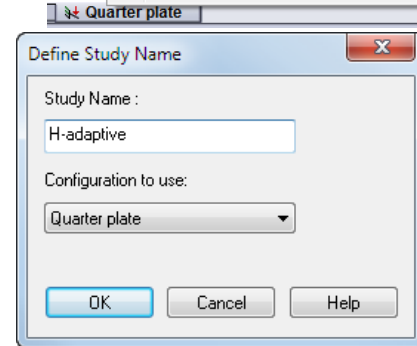

Step 2 Setting the h-adaptive Parameters

- 1 In the Simulation study tree, right-click `H-adaptive` and select **Properties**.
- 2 In the dialog box, in the **Options** tab, select **FFEPlus** under **Solver**.
- 3 In the **Adaptive** tab, under **Adaptive method**, select **h-adaptive**.
- 4 Under **h-Adaptive options**, do the following:
 - a) Move the **Target accuracy** slider to **99%**.
 - b) Set **Maximum no. of loops** to **5**.
 - c) Check **Mesh coarsening**.
- 5 Click **OK**.

Note: By duplicating the study, all the folders of the original study are copied to the new study. As long as the properties of the new study remain the same, you do not need to redefine material properties, loads, fixtures, etc.

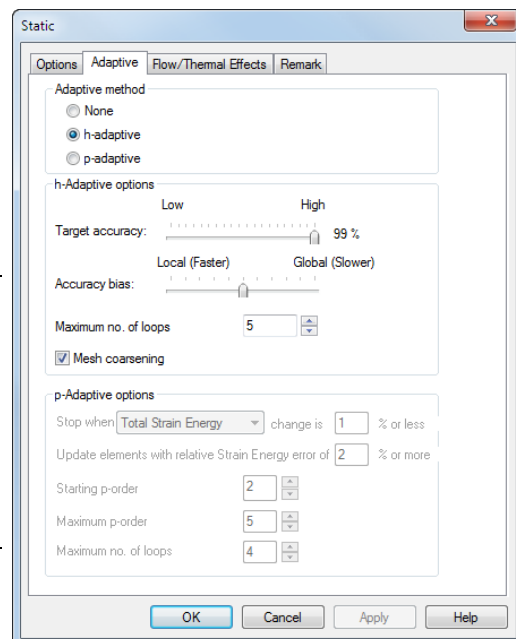





Step 3: Remeshing the Model and Running the Study

- 1 In the SolidWorks Simulation Manager tree, right-click the Mesh folder and select **Create Mesh**.

A warning message appears stating that remeshing will delete the results of the study.

- 2 Click **OK**.

The **Mesh PropertyManager** appears

- 3 Type **125mm (4.92in)** for **Maximum element size**  and accept the default values for the rest of the parameters (**Minimum element size** , **Min number of elements in a circle**  and **Element size growth ratio** ).

This large value for the global element size is used to demonstrate how the h-adaptive method refines the mesh to get accurate results.

- 4 Click . The image above shows the initial coarse mesh.
- 5 Right-click the **H-adaptive** icon and select **Run**.

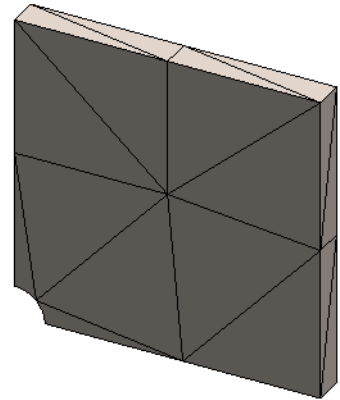

Step 4: Viewing Results

With the application of the h-adaptive method the original mesh size is reduced. Notice the transition of the mesh size from a coarser mesh (plate boundaries) to a finer mesh at the location of the central hole.

To view the converted mesh, right-click the Mesh icon and select **Show Mesh**.

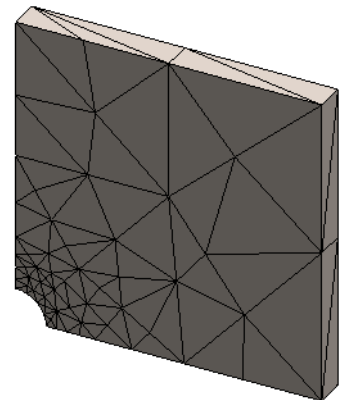

View normal stress in the global X-direction

In the SolidWorks Simulation Manager tree, double-click the **Stress2 (X-normal)** plot in the Results folder .

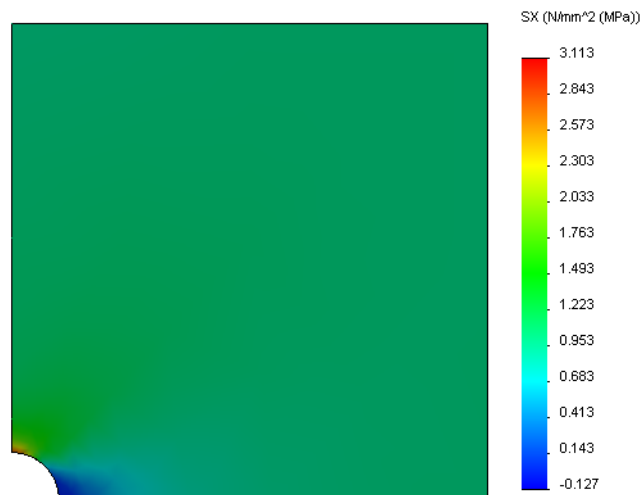



The analytical value for the maximum normal stress is $\sigma_{\max} = 3.113 \text{ MPa}$ (451.5) psi.

The SolidWorks Simulation result with the application of the h-adaptive method is $SX = 3.113 \text{ MPa}$, which is closer to the analytical solution (approximate error: 2.9%).

Note: The desired accuracy set in the study properties (in your case 99%) does not mean that the resulting stresses will be within the maximum error of 1%. In finite element method measures other than stresses are used to evaluate the accuracy of the solution. However, it can be concluded that as the adaptive algorithm refines the mesh, the stress solution becomes more accurate.

Step 9 Viewing Convergence Graphs

- 1 In the Simulation study tree, right-click the Results folder  and select **Define Adaptive Convergence Graph**.
- 2 In the PropertyManager, check all options and click .

The convergence graph of all checked quantities is displayed.

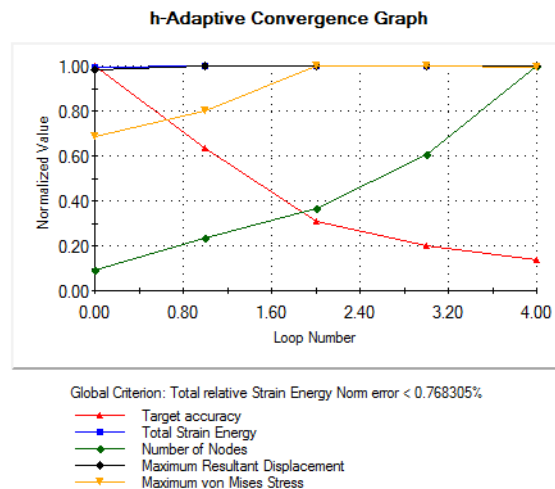

Note: To further improve the accuracy of the solution, it is possible to continue with the h-adaptivity iterations by initiating subsequent study runs. Each subsequent study run uses the final mesh from the last iteration of the previous run as the initial mesh for the new run. To try this **Run** the H-adaptive study again.

5 Minute Assessment- Answer Key

- 1 If you modify material, loads or fixtures, the results get invalidated while the mesh does not, why?

Answer: Material, loads and fixtures are applied to geometry. The mesh remains valid as long as geometry and mesh parameters have not changed. Results become invalid with any change in material, loads, or fixtures.

- 2 Does changing a dimension invalidate the current mesh?

Answer: Yes. The mesh approximates the geometry so any change in geometry requires meshing.

- 3 How do you activate a configuration?

Answer: Click the ConfigurationManager tab  and double-click the desired configuration from the list. You can also activate the configuration associated with a study by right-clicking the study's icon and selecting **Activate SW Configuration**.

- 4 What is a rigid body motion?

Answer: A rigid body mode refers to the body as a whole without deformation. The distance between any two points on the body remains constant at all times. The motion does not induce any strains or stresses.

- 5 What is the h-adaptive method and when is it used?

Answer: The h-adaptive method is a method that tries to improve the results of static studies automatically by estimating errors in the stress field and progressively refining the mesh in regions with high errors until an estimated accuracy level is reached.

- 6 What is the advantage of using h-adaptive to improve the accuracy compared to using mesh control?

Answer: In mesh control, you must specify the mesh size and the regions in which you need to improve the results manually. The h-adaptive method identifies regions with high errors automatically and continues to refine them until the specified accuracy level or the maximum allowed number of iterations is reached.

- 7 Does the number of elements change in iterations of the p-adaptive method?

Answer: No. The p-adaptive method increases the order of the polynomial to improve results in areas with high stress errors.

In Class Discussion — Creating Frequency Study

Ask the students to create frequency studies for the Plate-with-hole model for the `Whole plate` and `Quarter plate` configurations. To extract natural frequencies of the plate, no fixtures (except those controlling the symmetry of the quarter plate model) will be applied.

Explain that symmetry fixtures should be avoided in frequency and buckling studies since only symmetric modes are extracted. All anti-symmetric modes will be missed. Also explain the presence of the rigid body modes due to the lack of the fixtures.

Create a frequency study based on the `Whole plate` configuration

- 1 Activate the `Whole plate` configuration.
- 2 Click **Simulation, Study** in the main SolidWorks menu on the top of the screen.
The **Study** PropertyManager appears.
- 3 Under **Name**, type `Freq-Whole`.
- 4 Under **Type**, select **Frequency**.
- 5 Click .

Set the properties of the frequency study

- 1 Right-click the `Freq-Whole` icon in the SolidWorks Simulation Manager and select **Properties**.
The **Frequency** dialog box appears.
- 2 Set **Number of frequencies** to **15**.
- 3 Under **Solver** select **FFEPlus**.
- 4 Click **OK**.

Apply material

Drag-and-drop the `Plate-with-hole` folder in the `Whole plate` study to the `Freq-Whole` study.

The material properties of the `Whole plate` study are copied to the new study.





Apply loads and fixtures

Note: Both the fixtures and the pressure will not be considered in the frequency analysis. We are interested in the natural frequencies of fully unconstrained and unloaded plate.

Models without any fixture applied are allowed only in the frequency and buckling studies. In all other types of studies, proper fixtures must be applied.

Mesh the model and run the study

- 1 Right-click the `Mesh` icon and select **Create Mesh**.
- 2 Expand **Options**.
- 3 Check **Run (solve) the analysis**.
- 4 Expand **Mesh Parameters**

- 5 Click  to accept the default setting for all mesh parameters (**Maximum element size** , **Minimum element size** , **Min number of elements in a circle**  and **Element size growth ratio** ).

Listing resonant frequencies and viewing mode shapes

- 1 Right-click the **Results** folder and select **List Resonant Frequencies**.

The **List Modes** table lists the first fifteen non-zero frequencies.

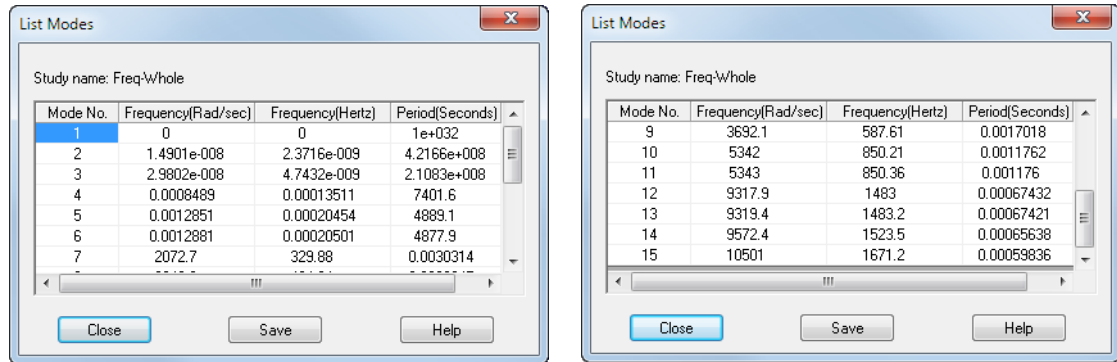

Mode No.	Frequency(Rad/sec)	Frequency(Hertz)	Period(Seconds)
1	0	0	1e+032
2	1.4901e-008	2.3716e-009	4.2166e+008
3	2.9802e-008	4.7432e-009	2.1083e+008
4	0.0008489	0.00013511	7401.6
5	0.0012851	0.00020454	4889.1
6	0.0012881	0.00020501	4877.9
7	2072.7	329.88	0.0030314
9	3632.1	587.61	0.0017018
10	5342	850.21	0.0011762
11	5343	850.36	0.001176
12	9317.9	1483	0.00067432
13	9319.4	1483.2	0.00067421
14	9572.4	1523.5	0.00065638
15	10501	1671.2	0.00059836

Note: The first several frequencies have zero, or near zero values. This result indicates that rigid body modes were detected and assigned very small (or zero) values. Because our model is fully unconstrained, six rigid body modes are found.

The first non-zero value corresponds to frequency #7 and has a magnitude of 2072.7 Hz. This is the first natural frequency of the unconstrained plate.

Close the List Modes window.

- 2 Expand **Results** and double-click the **Displacement1** plot.

The first rigid body mode shape appears in the graphics area.

Note: The frequency #1 corresponds to the rigid body mode where the plate translates along the global X direction as a rigid body. No deformation is therefore shown.

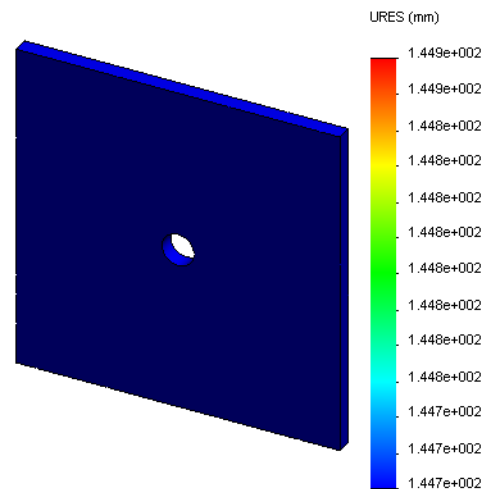

Viewing real 1st natural frequency of the plate

- 1 Right-click **Results** and select **Define Mode Shape/Displacement Plot**.
- 2 Under **Plot Steps**, enter **7** for **Mode Shape**.
- 3 Click **OK**.

Note: Frequency #7 corresponds to the first real natural frequency of the plate.

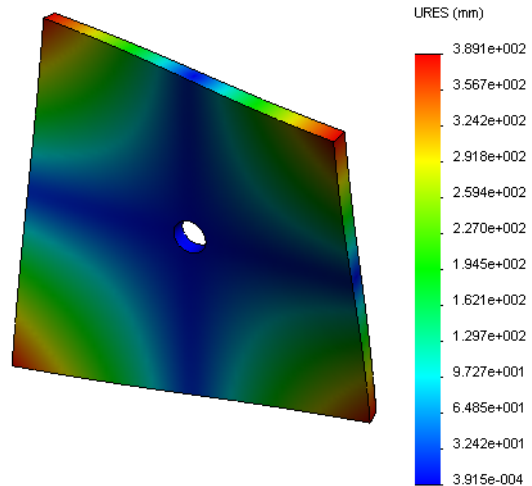

Animating the mode shape plots

- 1 Double-click the mode shape icon (i.e., **Displacement 6**) to activate it, and then right-click the icon and select **Animate**.

The **Animation PropertyManager** appears.

- 2 Click .

The animation is active in the graphics area.

- 3 Click  to stop the animation.

- 4 Click  to exit the animation mode.

Animating other mode shape plots

- 1 Double-click the mode shape icon for other frequencies (or define new mode shape plots for higher modes) and then right-click the icon and select **Animate**.
- 2 Also analyze the rigid body mode animations for frequencies #1 to #6.

Create a frequency study based on the Quarter plate configuration

- 1 Activate the **Quarter plate** configuration.
- 2 Follow the steps described above to create a frequency study named **Freq-quarter**.

Note: Drag-and-drop the **Fixtures** folder in the **Quarter plate** study to the **Freq-quarter** study and suppress the **Reference Geometry-1** fixture.

Listing resonant frequencies

The first five resonant frequencies are now listed as shown.

Animate the mode shape plots for the `Freq-quarter` study and compare them with those of the `Freq-Whole` study.

Mode No.	Frequency(Rad/sec)	Frequency(Hertz)	Period(Seconds)
1	0.0021973	0.00034971	2859.5
2	3050.1	485.44	0.00206
3	3700.2	588.9	0.0016981
4	9598.9	1527.7	0.00065457
5	17460	2778.9	0.00035986

Note: Because we analyzed only a quarter of the model antisymmetric modes are not captured in the `Freq-quarter` study. For this reason, frequency analysis of the full model is strongly recommended.

Because the `Symmetry-1` fixture restrains the model in certain directions, only one rigid body mode (zero frequency mode) is detected.

Projects — Modeling the Quarter Plate with a Shell Mesh

Use shell mesh to solve the quarter plate model. You will apply mesh control to improve the accuracy of the results.

Tasks

- 1 Click **Insert, Surface, Mid Surface** in the main SolidWorks menu on the top of the screen.
- 2 Select the front and back surfaces of the plate as shown.
- 3 Click **OK**.
- 4 Create a **Static** study named Shells-quarter.
- 5 Expand the Plate-with-hole folder, right-click the SolidBody and select **Exclude from Analysis**.
- 6 Define **25mm (Thin formulation)** shell. To do this:
 - a) Right-click the SurfaceBody in the Plate-with-hole folder of the Simulation study tree and select **Edit Definition**.
 - b) In the **Shell Definition** PropertyManager, select **mm** and type **25 mm** for **Shell thickness**.
 - c) Click .
- 7 Assign **Alloy Steel** to the shell. To do this:
 - a) Right-click the Plate-with-hole folder and select **Apply Material to All Bodies**.
 - b) Expand SolidWorks Materials library and select **Alloy Steel** from the Steel category.
 - c) Select **Apply** and **Close**.
- 8 Apply symmetry fixtures to the two edges shown in the figure.

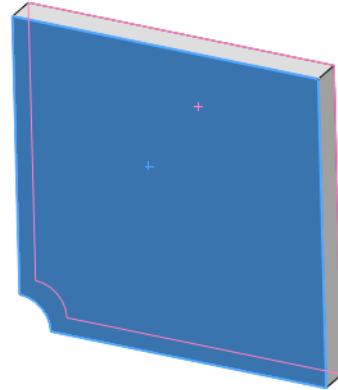

Note: For a shell mesh, it is sufficient to restrain one edge instead of the face.

Answer: Do the following:

- a) Right-click the **Fixtures** folder and select **Advanced Fixtures**.
- b) In the **Faces, Edges, Vertices for Fixture** field select the edge indicated in the figure.
- c) In the **Face, Edge, Plane, Axis for Direction** field select **Plane3**.
- d) Restrain the **Normal to Plane** translation and **Along Plane Dir 1** and **Along Plane Dir 2** rotations.
- e) Click .

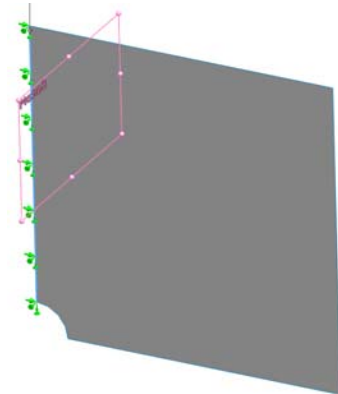

- 9 Using the identical procedure to apply a symmetry fixture to the other edge shown in the figure. This time use **Plane2** feature for **Face, Edge, Plane, Axis for Direction** field.

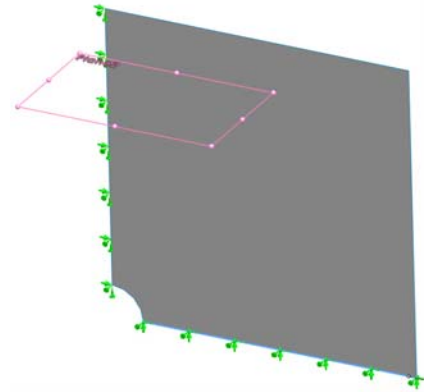

- 10 Apply **1 N/mm² (MPa) Pressure** to the edge shown in the figure.

Answer: Do the following:

- Right-click the **External Loads** folder and select **Pressure**.
- Under **Type** select **Use reference geometry**.
- In the **Faces, Edges for Pressure** field select the vertical edge shown in the figure.
- In the **Face, Edge, Plane, Axis for Direction** field select the edge indicated in the figure.
- Specify **1 N/mm² (MPa)** in the **Pressure Value** dialog and check the **Reverse direction** checkbox.
- Click .

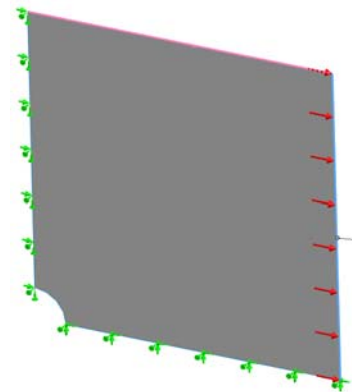

- 11 Apply mesh control to the edge shown in the figure.

Answer: Do the following:

- In the Simulation study tree, right-click the **Mesh** icon and select **Apply Mesh Control**. The **Mesh Control PropertyManager** appears.
- Select the edge of the hole as shown in the figure.
- Click .

- 12 Mesh the part and run the analysis.

Answer: Do the following:

- In the SolidWorks Simulation Manager tree, right-click the **Mesh** icon and select **Create Mesh**.
- Use the default mesh parameters.
- Check **Run (solve) the analysis**.
- Click .

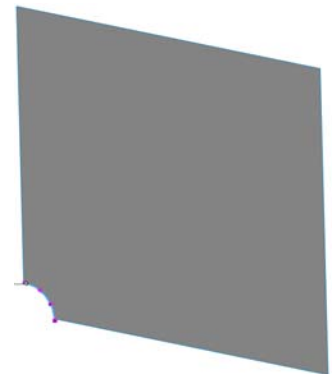

- 13 Plot the stress in the X-direction. What is the maximum SX stress?

Answer: Do the following:

- In the SolidWorks Simulation Manager tree, right-click the **Results** folder and select **Define Stress Plot**. The **Stress Plot** dialog box appears.
- Select **SX: X Normal stress** in the **Component** field.

Lesson 2: Adaptive Methods in SolidWorks Simulation

- c) Select **N/mm² (MPa)** for **Units**.
- d) Click .
- e) The maximum SX normal stress is 2.96 MPa (429.31 psi.)

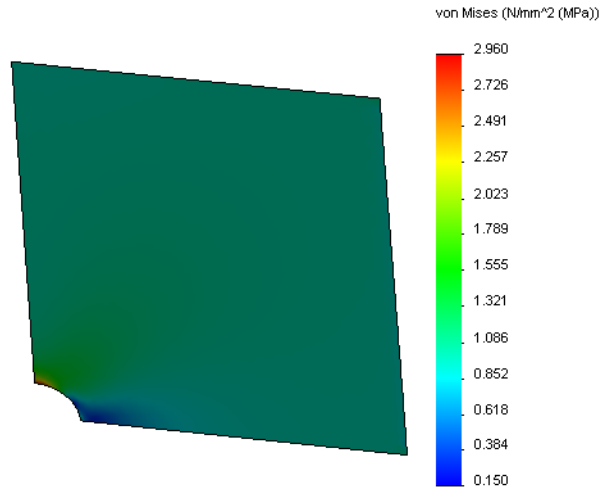

14 Calculate the error in the SX normal stress using the following relation:

$$ErrorPercentage = \left(\frac{SX_{Theory} - SX_{COSMOS}}{SX_{Theory}} \right) 100$$

Answer:

The theoretical solution for the maximum SX stress is: SXmax = 3.0245 MPa (438.67 psi).

The error percentage in the maximum SX normal stress is 2.1%

In most design analysis applications, an error of about 5% is acceptable.

Lesson 2 Vocabulary Worksheet - Answer Key

Name _____ Class: _____ Date: _____

Fill in the blanks with the proper words.

- 1 A method that improves stress results by refining the mesh automatically in regions of stress concentration: **h-adaptive**
- 2 A method that improves stress results by increasing the polynomial order: **p-adaptive**
- 3 The type of degrees of freedom that a node of a tetrahedral element has: **translational**
- 4 The types of degrees of freedom that a node of a shell element has: **translational and rotational**
- 5 A material with equal elastic properties in all directions: **isotropic**
- 6 The mesh type appropriate for bulky models: **Solid Mesh**
- 7 The mesh type appropriate for thin models: **Shell Mesh**
- 8 The Mesh type appropriate for models with thin and bulky parts: **Mixed Mesh**

Lesson 2 Quiz - Answer Key

Name: _____ Class: _____ Date: _____

Directions: Answer each question by writing the correct answer or answers in the space provided.

1 How many nodes are there in draft and high quality shell elements?

Answer: 3 for draft and 6 for high quality

2 Does changing the thickness of a shell require remeshing?

Answer: No.

3 What are adaptive methods and what is the basic idea for their formulation?

Answer: Adaptive methods are iterative methods that try to improve the accuracy of static studies automatically. They are based on estimating the error profile in a stress field. If a node is common to several elements, the solver gives different answers at the same node for each element. The variation of such results provides an estimate of the error. The closer these values are to each other, the more accurate the results are at the node.

4 What is the benefit in using multiple configurations in your study?

Answer: You can experiment with your model's geometry in one document. Each study is associated with a configuration. Changing the geometry of a configuration affects only the studies associated with it.

5 How can you quickly create a new study that has small differences from an existing study?

Answer: Drag-and-drop the icon of an existing study onto the top icon of the SolidWorks Simulation Manager tree and then edit, add, or delete features to define the study.

6 When adaptive methods are not available, what can you do to build confidence in the results?

Answer: Remesh the model with a smaller element size and rerun the study. If the changes in results are still significant, repeat the process until the results converge.

7 In which order does the program calculate stresses, displacements, and strains?

Answer: The program calculates displacements, strains, and stresses.

8 In an adaptive solution, which quantity converges faster: displacement, or stress?

Displacement converges faster than stress. This is due to the fact that stress is a second derivative of displacement.

Lesson Summary

- ❑ The application of adaptive methods is based on an error-estimation of the continuity of a stress field. Adaptive methods are available for static studies only.
- ❑ Adaptive methods improve the accuracy without user interference.
- ❑ The theoretical stress at the point application of a concentrated load is infinite. The stresses keep increasing as you use a smaller mesh around the singularity or use the h-adaptive method.
- ❑ The application of Mesh control requires the identification of critical regions before the study runs. Adaptive methods do not require the user to identify critical areas.
- ❑ Symmetry can be used, when appropriate, to reduce the problem size. The model should be symmetrical with respect to geometry, fixtures, loads, and material properties across the planes of symmetry.
- ❑ No fixtures are allowed in the frequency analysis and are manifested by the presence of rigid body modes (zero, or near zero value frequencies).
- ❑ Symmetry fixtures should be avoided in frequency and buckling studies as you can extract symmetrical modes only.
- ❑ Thin parts are best modeled with shell elements. The shell elements resist membrane and bending forces.
- ❑ Bulky models should be meshed with solid elements.
- ❑ Mixed mesh should be used when you have bulky and thin parts in the same model.

